



Kit Soul



USER MANUAL

G2+ 2-wire installation Art 7 Lite monitor



CONTENTS

Contents	2
Recommendations.....	3
System operation	3
FA-G2+/LITE power supply	4
Description	4
Installation	4
Soul panel-7/LITE	5 to 7
Description	5
Installation	6
Installation terminals	6
Configuration switches	7
Setting the audio level	7
Art 7 LITE/G2+ monitor	8 to 20
Description	8
Installation	9
Installation terminals	9
Configuration switches	9
Main menu	10
Settings menu	11 to 14
Door panel call screen	15
Communication screen	16
Image and communication settings	17
Timed 'do not disturb' menu	18 to 19
Intercom menu	20
Wiring diagrams	21 to 24
Cross sections and distances	21
One apartment with one access panel and one monitor	21
One apartment with two access panels and one monitor	21
One apartment with up to two access panels and up to four monitors in cascade	22
One apartment with up to two access panels and up to four monitors in distribution	22
Connection of a lock release	23
Connection of an auxiliary device at the relay output	23
Connection of an output button	24
Connection of an external camera	24
Connection for an apartment door button	24
Special codes	25 to 26
Cleaning the monitor	27
Cleaning the door panel	27
Compliance	28



RECOMMENDATIONS





- Preferably use a Golmar **RAP-GTWIN/HF** cable (2x1mm²).
- The wiring must run at least **40cm away from any other wiring.**
- **Always disconnect the power supply** before making modifications to the device.
- The installation and handling of these devices must be carried out by **authorised personnel.**
- Check all connections before starting the device.
- Always follow the instructions contained in this manual.





SYSTEM OPERATION

To make a call, the visitor needs to press the door panel button: an audible tone indicates that the call is being made and LED  on the door panel illuminates. At this moment, the apartment's monitor(s) receive(s) the call.

In systems with two access doors, the other door panel automatically disconnects; if another visitor attempts to call, a number of tones will indicate that the system is busy and LED  on the door panel will illuminate.

Upon receiving the call, the image will appear on the screen of the master monitor (and slave 1, if it exists) without the visitor knowing and icon  displayed on the screen will blink green. To view the image from slave monitors 2 or 3, press one of the buttons (located above the raised dots for the visually impaired) of the monitor to display the image. If the call is not answered within 45 seconds, door panel LED  will turn off and the system will become free.

To establish communication, press the button below the off-the-hook icon  shown on the screen. Door panel LED  will illuminate. Communication will last for 90 seconds or until the button below on-the-hook icon  shown on the screen is pressed. When communication has ended, door panel LED  will turn off and the system will become free.

To open door  or activate auxiliary output  of the door panel, press the button below the icon  or press the hidden push button below the icon  displayed on the screen. A single press activates the lock release or auxiliary output for 3 seconds, and LED  on the door panel illuminates.

Detailed operation of the monitor is described on pp. 8 to 20.

FA-G2+/LITE POWER SUPPLY

Description

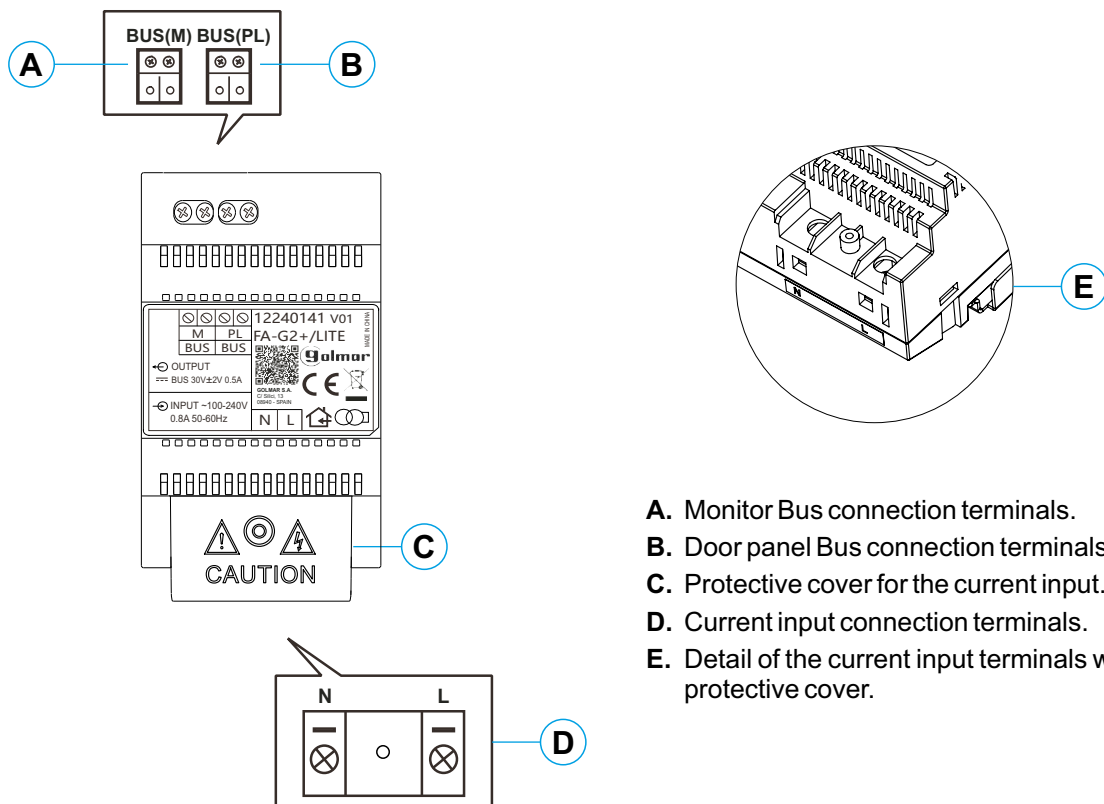

- A. Monitor Bus connection terminals.
- B. Door panel Bus connection terminals.
- C. Protective cover for the current input.
- D. Current input connection terminals.
- E. Detail of the current input terminals without protective cover.

Installation

The fitting and handling of the power supply must be carried out by authorised personnel in the absence of electrical current.

Install the power supply in a dry, protected and ventilated location. Make sure that the vents are not obstructed. Use a DIN 46277 rail for fastening (4 elements).

Note that current regulations stipulate that the power supply must be protected by a circuit breaker.

To prevent electric shock, do not remove the protective cover without first disconnecting the power supply. Replace it once all connections have been made.

Connect the wires to the installation terminals following the instructions in the diagrams.

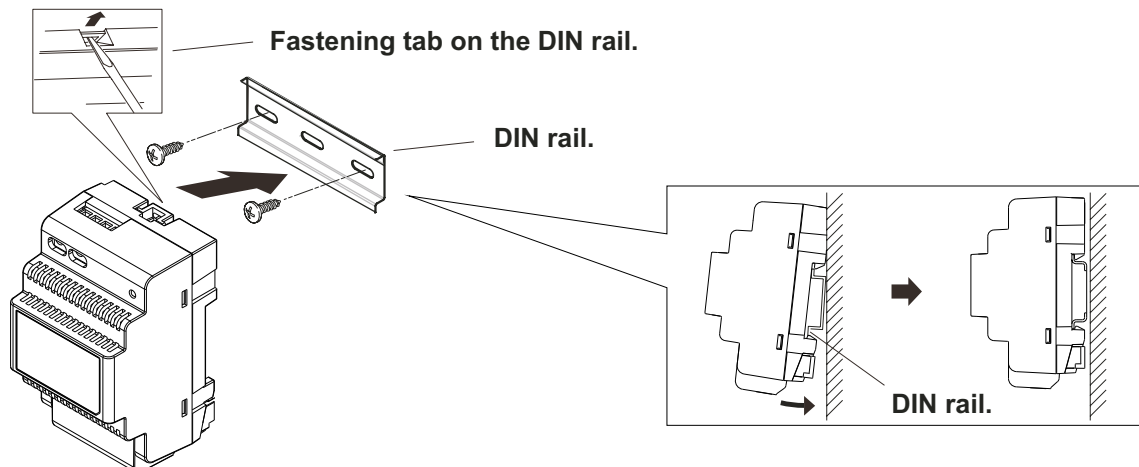

SOUL PANEL-7/LITE

Description

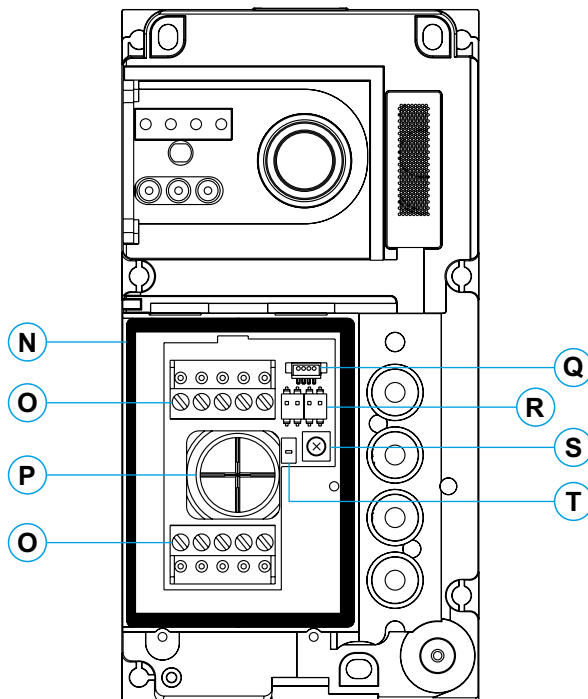
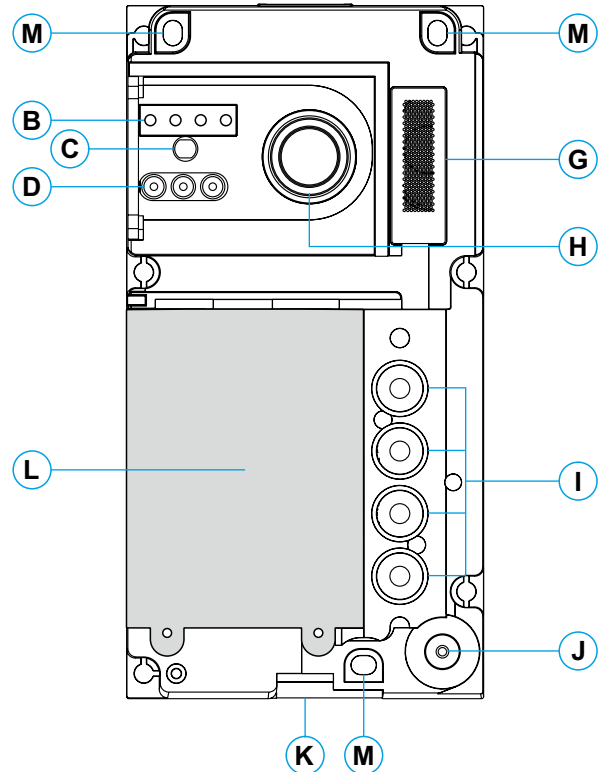
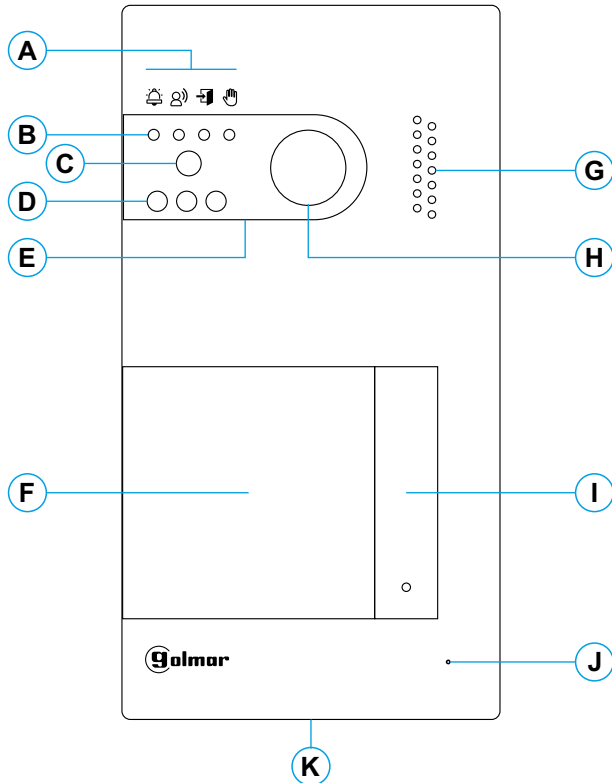

- A. System status icons:
 - 📞 Call in progress.
 - 📞 Communication established.
 - 🔒 Lock release activated.
 - 👤 System busy.
- B. System status indicator lights.
- C. Ambient lighting sensor.
- D. Night viewing lighting.
- E. Protective polycarbonate.
- F. Nameplate label.
- G. Speaker grill.
- H. Colour camera.
- I. Call button(s).
- J. Microphone hole.
- K. Front fixing screw.
- L. Illumination module.
- M. Wall fixing hole (x3). **Do not overtighten the fixing screws.**
- N. Illumination module gasket.
- O. Installation terminals.
- P. Cable grommet.
- Q. Illumination module connector.
- R. Configuration switches.
- S. Volume control potentiometer.
- T. No function.

SOUL PANEL-7/LITE

Installation

The door panel has been designed to withstand diverse environmental conditions. It is however advisable to take extra precautions to prolong its service life, such as locating it in a covered area.

For optimum image quality, avoid direct contact from light sources (sunshine, street lights, etc.).

For correct installation: (locate the top of the door panel at a height of 1.65m).

1. Remove the metal front piece of the door panel by loosening the bottom screw with the Allen key supplied. On the back of the front piece, you will find the button personalisation label.
2. Remove the screws that secure the Illumination module.
3. Present the door panel to the wall, positioning the top at 1.65m. Pass the installation cables through the cable grommet.
4. Drill three 6mm holes at the indicated points (M), see p. 5. Insert the plugs supplied and fix the door panel to the wall using the screws supplied.
5. Connect the cables to the removable terminals following the instructions in the installation diagrams.

Before replacing the illumination module and closing the door panel, perform the necessary settings (address door panel, audio level setting, etc.), as indicated throughout this manual. Make sure that the illumination module gasket is properly fitted.

Installation terminals (O)

For ease of installation, the installation terminals are removable and supplied in a separate bag. Once the terminals are wired, place them in position.

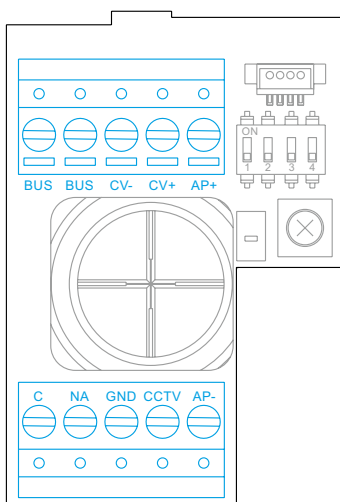

BUS, BUS: communications bus (non-polarised).

CV-, CV+: lock release output 12Vdc (maximum 270mA).

AP+, AP-: remote activation button connection. **Note: For correct operation, the monitor's address 1 must be connected to the Bus.**

IMPORTANT: Installation with 2 access door panels and AP button on both door panels, one of the door panels must connect the AC lock release (instead of DC lock release). SAR-12/24 relay & a TF-104 transformer required, see pages 23 to 24.

C, NA: potential-free relay output (maximum 6A/24V).

GND, CCTV: input for external analogue camera.

SOUL PANEL-7/LITE

Configuration switches (R)

Configuration changes should be made with the equipment turned off. If they are performed with the equipment turned on, disconnect it for 10 seconds after any modification.

All switches are factory set to OFF.

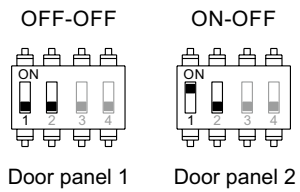

Switch 1.

Defines the door panel address.

Switch 2, must be OFF.

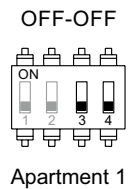

Switches 3 and 4 must be OFF.

Setting the audio level

If the audio volume on the door panel after starting up the device is not adequate, use the volume control potentiometer (S). This setting affects the communication and confirmation tone audio level.

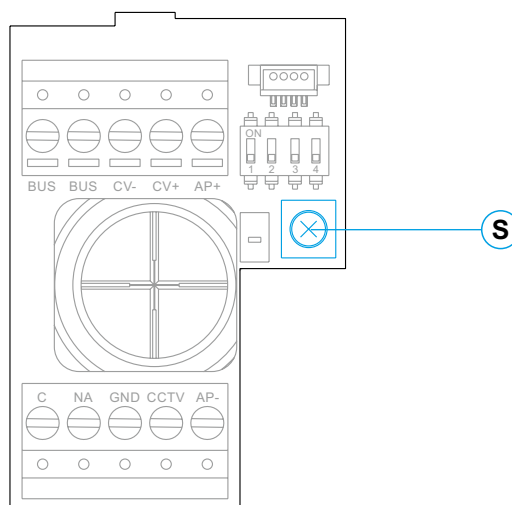

ART 7 LITE/G2+ MONITOR

Description

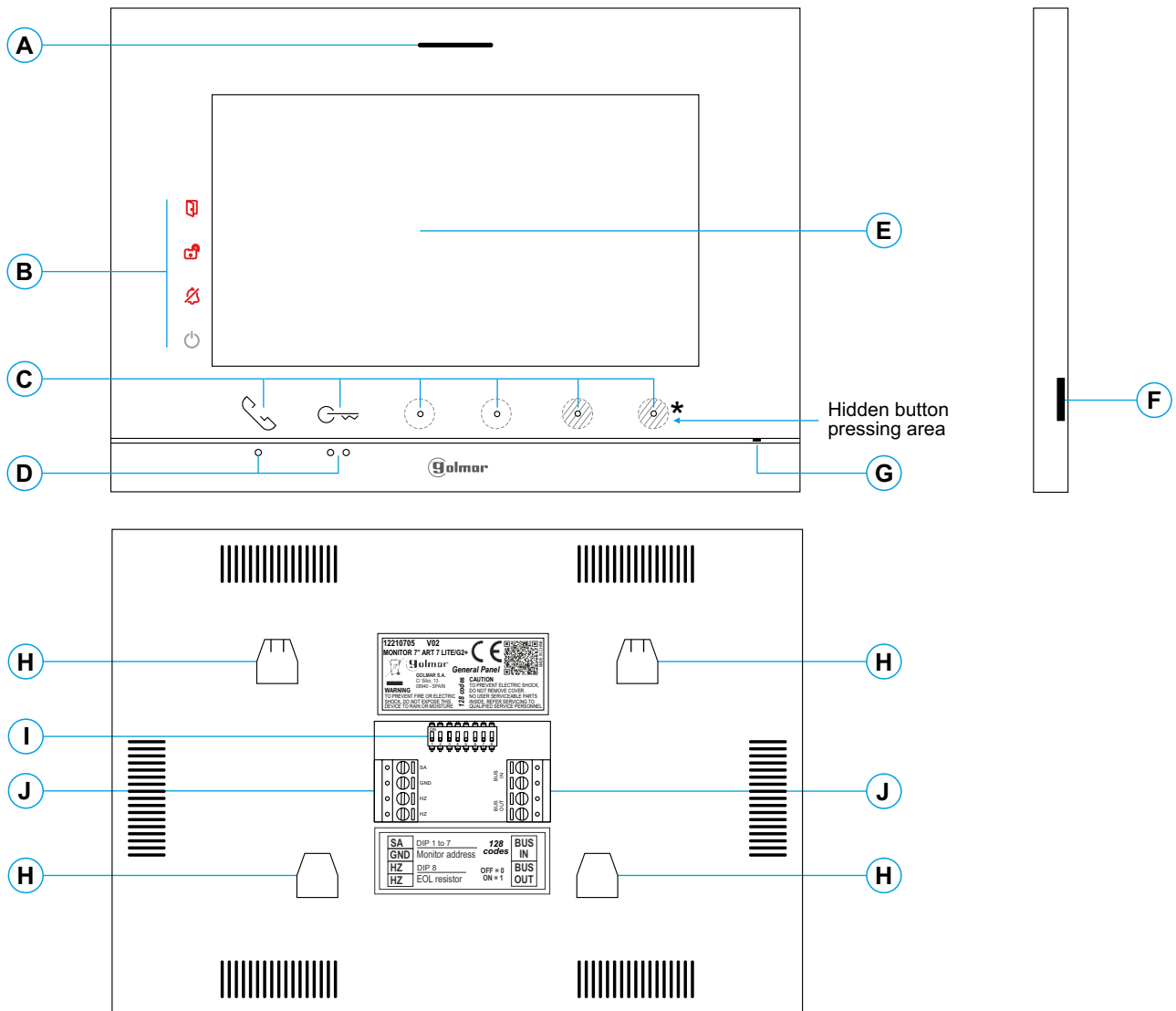

- A.** Speaker.
- B.** Notification icons:
 - ⏻ Power on indicator.
 - 🚫 Do not disturb.
 - 🔔 Auxiliary relay activated.
 - 🚪 Door opening.
- C.** Hidden button indicator LEDs*[⦿]:
 - To access the main menu (monitor in standby), press either of the 2 buttons 📞 / 🚪 located above the raised dots for the visually impaired (see page 10).
 - 📞 In call/ communication: press button to start or end the communication.
 - 🚪 In call/ communication: one press will activate the lock release 1 for 3 seconds.
 - In call/ communication: an LED shows the location of each of the hidden buttons.
 - The function of each button/hidden button is shown on the monitor screen with an icon located just above each button (see pp. 10 to 20).
- D.** Raised dots for the visually impaired.
 - In standby:
Above the raised dots for the visually impaired ●/●● are the push buttons that access the main menu.
 - In call
 - Above this raised dot is the 'Start/end communication' button 📞.
 - Above this raised dot is the 'Door opening' button 🚪.
- E.** 7" TFT colour screen.
- F.** Golmar use.
- G.** Microphone.
- H.** Wall mounting connector fixing (x4).
- I.** Configuration switches.
- J.** Installation terminals.

ART 7 LITE/G2+ MONITOR

Installation

Avoid dusty or smoky environments or locations near sources of heat.

For proper installation, use the template supplied with the product.

1. Position the top of the template at a height of 1.65m.
2. If you are going to use an embedding box to pass the wiring through, make sure that it is in line with the holes corresponding to the box model chosen and fix the connector. If you prefer to fix the connector directly to the wall, make four 6mm holes at the points indicated (A), insert the wall plugs supplied and screw in the connector.
3. Pass the installation wires through the middle hole and connect them to the removable terminals as shown in the wiring diagrams. Before connecting the removable terminals to the monitor, configure the switch as indicated below.
4. Connect the removable terminals to the monitor and place the monitor in front of the connector, making sure the fixings line up. Move the monitor downwards to secure it.

Installation terminals (J)

For ease of installation, the installation terminals are removable and supplied in a separate bag. Once the terminals are wired, place them in position.

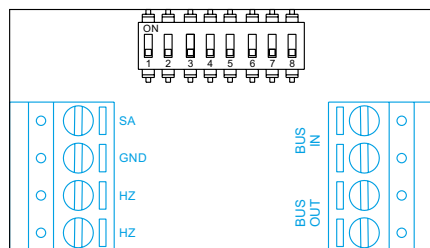

BUS IN: Communication bus input to monitor (non-polarised).

BUS OUT: Communication bus output to additional monitor (non-polarised).

SA, GND: Auxiliary call repeater output (max 50mA/12V), relay SAR-12/24.

HZ, HZ: Apartment front door button input:

Connect only on the master monitor. The signal received is then transmitted to the slave monitors in the same apartment through the BUS.

Note: HZ push button function mode: When HZ push button is pressed will be call tone and activate the output of auxiliary call repeater with standby monitor, call process, communication process (HZ tone with lower audio level), intercom process and "Do not disturb" mode.

Configuration switches (I)

Switches 1 to 7.

These assign the address of the corresponding monitor to its call button on the door panel. Switches 2 to 7 must remain in the OFF position.



Switch 8.

This activates the end-of-line resistance in the ON position. Activate it in monitors where the bus cable ends. Deactivate it only in intermediate monitors.

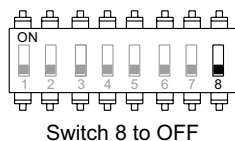
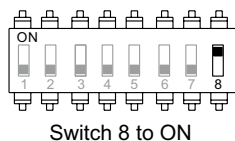





To define whether the monitor is master or slave:

To define whether the monitor is master or slave (see special codes page 25 to 26). Each apartment must have one master monitor, and only one.

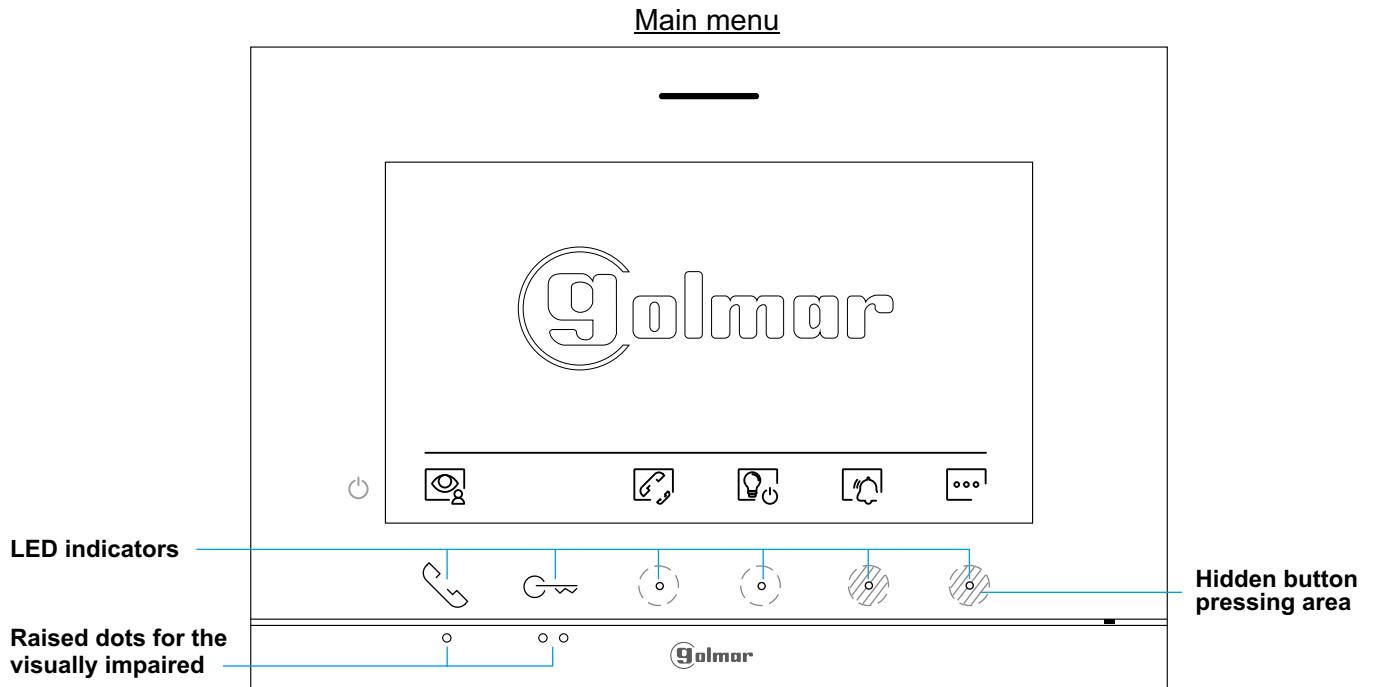
ART 7 LITE/G2+ MONITOR

Main menu



 If the device is in standby (screen switched off), to access the main menu, press either of the 2 buttons  /  (located above raised dots ●/●● for the visually impaired) on the monitor. Then press the button/ hidden button located just below the corresponding icon. The device will return to standby mode after 20 seconds without activity.



Press the button below icon  to display the image from the master door panel. Note: This enables the door panel camera to be changed, the audio on the corresponding door panel to be activated and the door to be opened (see p. 15).





Press the hidden button below icon  to access the menu of the intercom between other monitors in the same apartment or other apartments (see pp. 20).



No function.



Press the hidden button below icon  to access the 'Do not disturb' menu and enable the function. If the monitor is in 'Do not disturb' mode, press the hidden button below icon  to disable the function: If the monitor is in 'Do not disturb' mode, the ringtone on the monitor does not sound when a call (see note "HZ" page 9) is received and the notification icon  will illuminate.



Press the hidden button below icon  to make changes to the system settings (see pp. 11-14).

ART 7 LITE/G2+ MONITOR

Settings menu

Settings menu

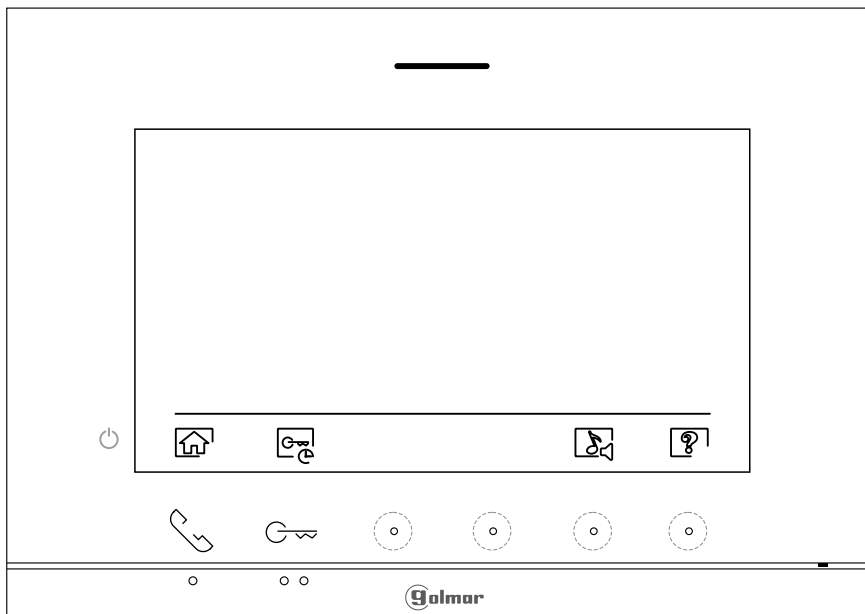

Returning to the main menu: Press the hidden button below icon  to return to the main menu.







The 'About' screen provides information about the monitor, such as the software version, address and whether it is master or slave (M, S1, S2 or S3).

It enables updated versions of the manual to be downloaded to a mobile or tablet, for which it is necessary to have a QR code scanner app installed.

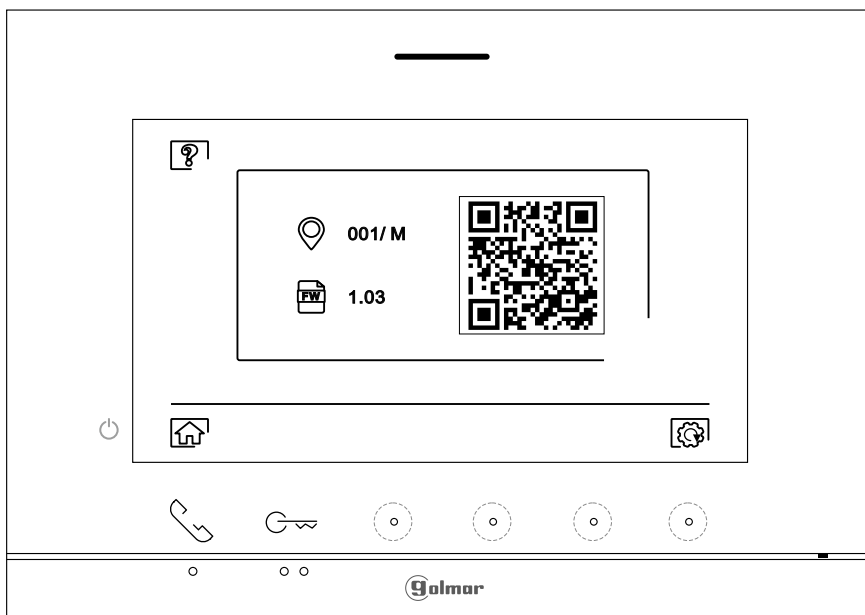
It enables the monitor to be restored to factory settings, such as melodies, call volume, etc.

Press the button below icon  to return to the settings menu.



To restore the monitor to factory settings, press the hidden button below icon  to access the factory reset menu, then press the hidden button below icon  to perform this function. Press the button below icon  to return to the 'About' screen.









Press the button below icon  to return to the settings menu.

Continued overleaf

Continued from previous page.
ART 7 LITE/G2+ MONITOR



Settings menu

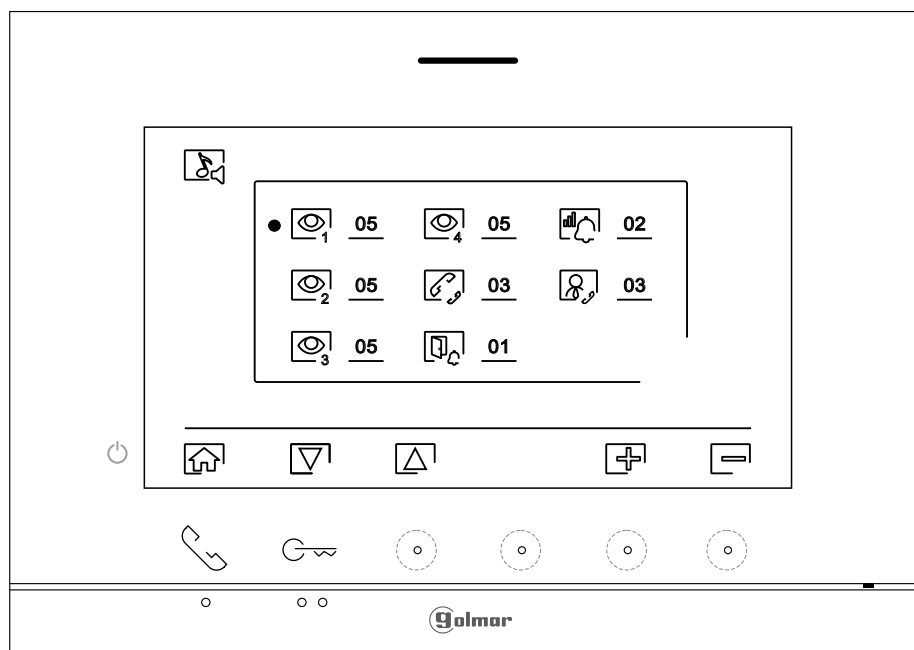

Selecting the melody and call volume: Press the hidden button below icon  to access the settings screen. In order to identify the origin of the calls when you are not in front of the monitor, select different melodies and the desired call volume. Go to the option to be modified by pressing the button/ hidden button below corresponding icons / , then press the hidden buttons below corresponding icons /  to select the melodies and desired call volume. Press the button below icon  to validate the changes made and return to the settings menu.

Option selection screen



Settings "automatic door opening" mode: This selection is visible in the settings menu, with the special code '0441' (Doctor mode) already entered in the monitor for automatic door opening  (see special codes pp. 25 to 26). Then press the button below icon  to access the settings menu.

Option selection screen

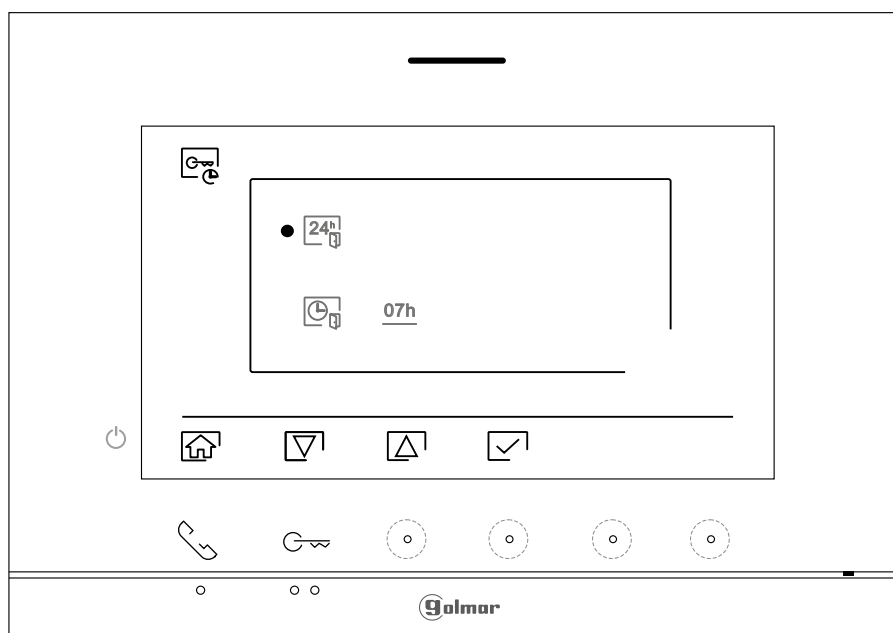

Continued from previous page.
ART 7 LITE/G2+ MONITOR

Settings menu



To enable the automatic door opening (after 3 seconds of receiving a call from the door panel), go to the option with icon by pressing the button/ hidden button below corresponding icon / and select the option by pressing the hidden button below icon . Press the button below icon to return to the settings menu.

If you wish disable the automatic door opening , go to the option with icon by pressing the button/ hidden button below corresponding icon / and, deselect the option by pressing the hidden button below icon . Press the button below icon to return to the settings menu.

(This function is disabled by default. To enable it, see pp. 25 to 26).



To set a period of time for automatic door opening (after 3 seconds of receiving a call from the door panel), go to the option with icon by pressing the button/ hidden button below corresponding icon / and select the option by pressing the hidden button below icon . Then you can set a period of time (from 1h to 24h) for 'opening the door' function mode, by pressing corresponding hidden buttons / , and validate the changes made by pressing the hidden button below icon . Press the button below icon to return to the settings menu.

(This function is disabled by default. To enable it, see pp. 25 to 26).

Time period setting screen

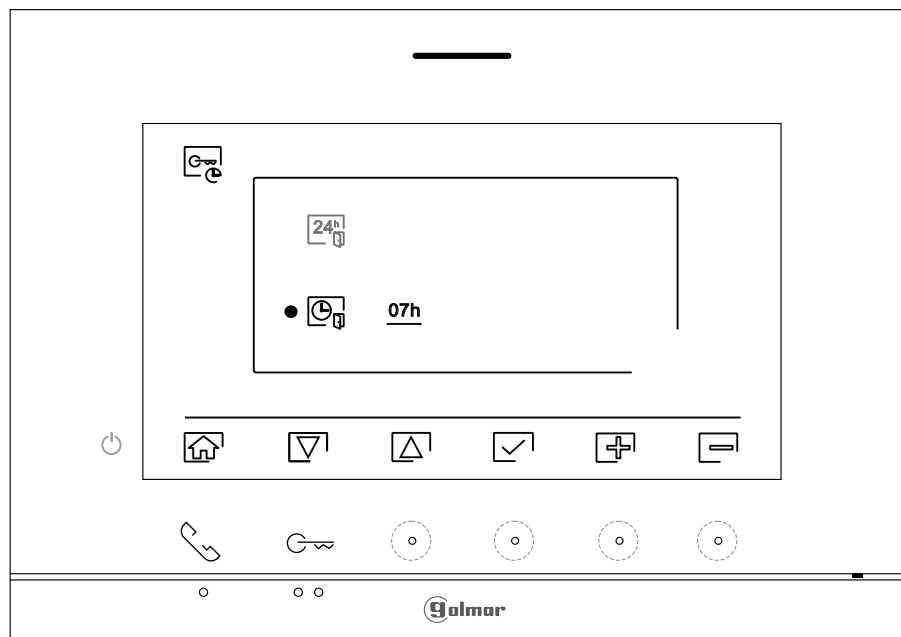

Continued from previous page.
ART 7 LITE/G2+ MONITOR

Settings menu



Press the button below icon to return to the main menu. If the 'automatic door opening' mode is enable (see pages 12 to 13) in the top left of the screen the icon will be displayed in the main menu and the notification icon will blink.

Settings menu

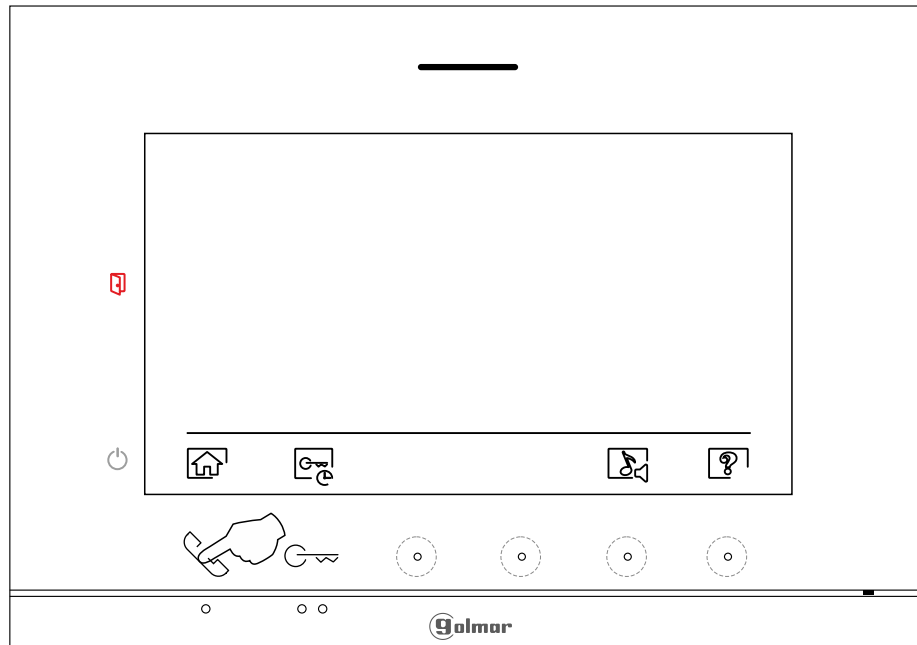

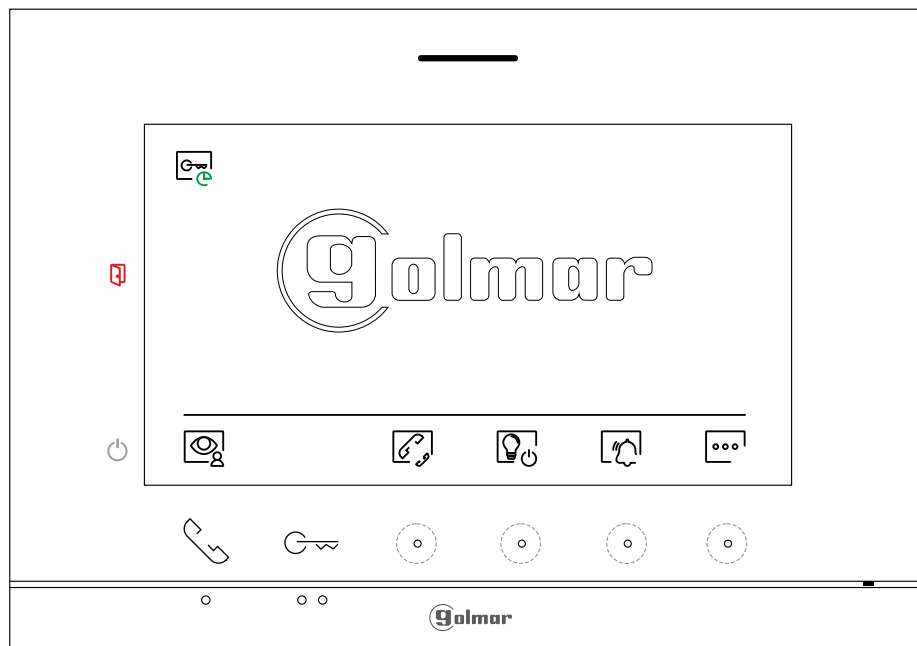

Main menu



ART 7 LITE/G2+ MONITOR

Door panel call screen



This screen is displayed when you receive a call or when you press the button below icon  of the main menu. During a call, icon  displayed on the screen will blink green (during the call process). In the top right of the screen, the source of the image is displayed. The call has a duration of 45 seconds.



Press the hidden button below icon  to cancel the current call or display and return to the main menu.





No function





Press the hidden button below icon  to change the source of the image as long as the system has more than one door panel or has an external camera connected and display has been activated (see pp. 25 to 26). It is possible to make the change during display, call and communication processes.





Press the button below icon  /  to start or end audio communication with the door panel displayed respectively. Communication has a maximum duration of 90 seconds. Once communication has ended, the screen will turn off.



Press the button below icon  to activate the lock release (or device connected to the CV output of the door panel) for 3 seconds (factory setting, see pp. 25 to 26). During activation, indicator  will illuminate.



Press the hidden button below icon  to activate the lock release (or device connected to the relay output of the door panel) for 3 seconds (factory setting, see pp. 25 to 26). During activation, indicator  will illuminate.





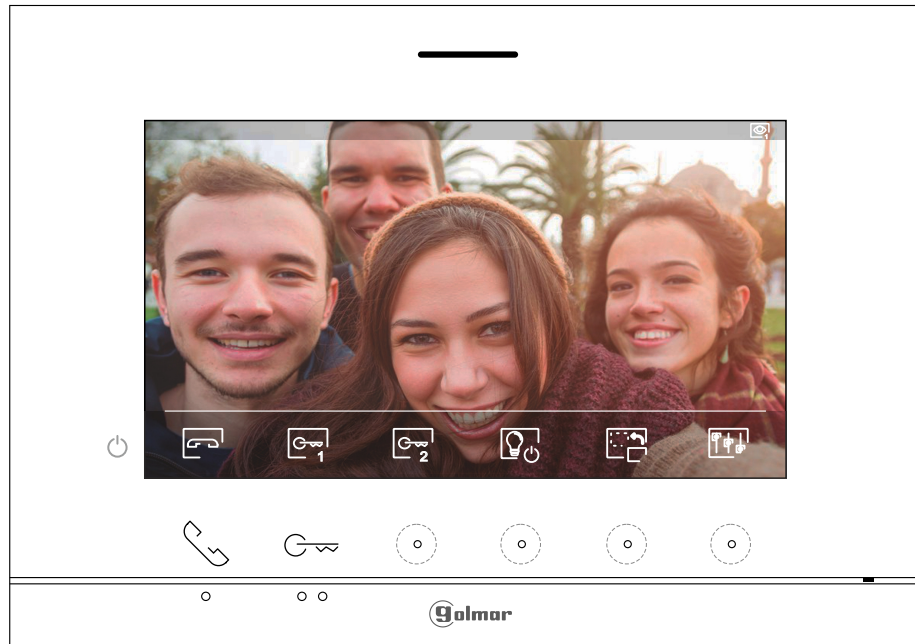

ART 7 LITE/G2+ MONITOR

Communication screen



This screen is displayed during a communication process. In the top right of the screen, the source of the image is displayed.



Press the hidden button below icon  to access the image and monitor in communication volume settings menu. Go to the option to be modified by pressing the button/ hidden button below corresponding icons  / , change to the desired level by pressing the hidden buttons below corresponding icons  /  and validate the changes made by pressing the button below icon , (see p. 17)





No function.





Press the hidden button below icon  to change the source of the image as long as the system has more than one door panel or has an external camera connected and display has been activated (see pp. 25 to 26). It is possible to make the change during display, call and communication processes.





Press the button below icon  /  to start or end audio communication with the door panel displayed respectively. Communication has a maximum duration of 90 seconds. Once communication has ended, the screen will turn off.



Press the button below icon  to activate the lock release (or device connected to the CV output of the door panel) for 3 seconds (factory setting, see pp. 25 to 26). During activation, indicator  will illuminate.







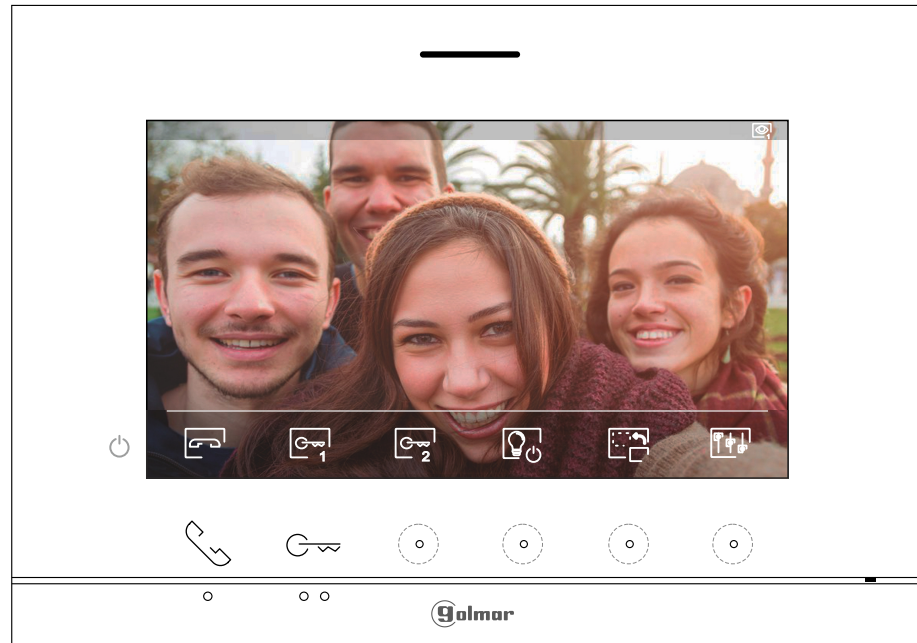

Press the hidden button below icon  to activate the lock release (or device connected to the relay output of the door panel) for 3 seconds (factory setting, see pp. 25 to 26). During activation, indicator  will illuminate.

ART 7 LITE/G2+ MONITOR

Image and communication settings

During a communication process, press the hidden button below icon  to access the image and monitor in communication volume settings menu.



The following settings menu will then appear (brightness, contrast, colour and monitor in communication volume). Go to the option to be modified by pressing the button/ hidden button below corresponding icons  /  and change to the desired level by pressing the hidden buttons below corresponding icons  / . To exit the screen settings and monitor volume menu and validate the changes made, press the button below icon .

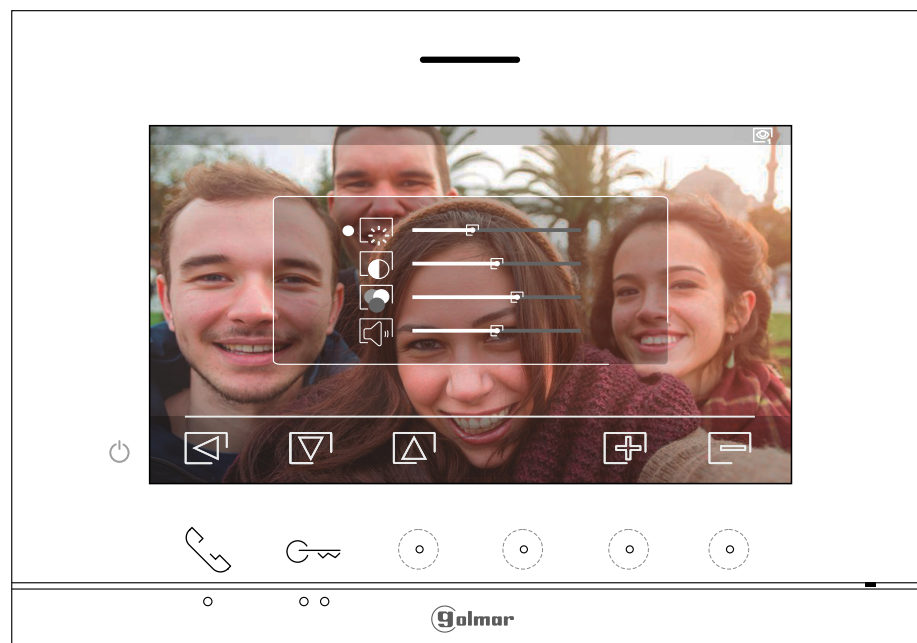

ART 7 LITE/G2+ MONITOR

Period of time for 'do not disturb' mode menú



Do not disturb' mode settings: If the device is in standby (screen switched off), to access the main menu, press either of the 2 buttons / (located above raised dots ●/●● for the visually impaired) on the monitor. Then press the hidden button below icon to access the settings screen. You can set a period of time during which the monitor will not sound when receiving calls (see note "HZ" page 9). To do so, enable the timer function and choose the time period. From the main menu, you can disable the 'Do not disturb' function regardless of the timer status.

Option selection screen

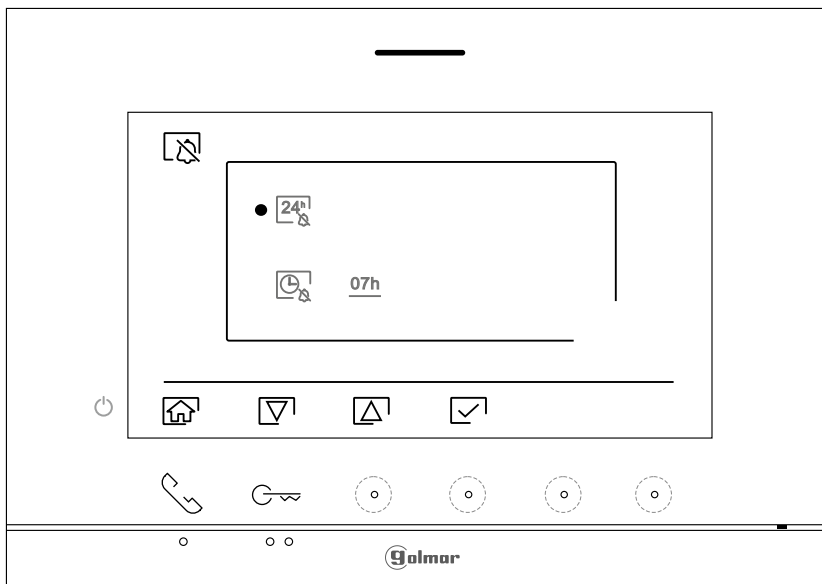

To enable the 'Do not disturb' mode in which the monitor will not sound when receiving calls (see note "HZ" page 9), go to the option with icon by pressing the button/ hidden button below corresponding icon / and select the option by pressing the button below icon and the notification icon will illuminate. Press the button below icon to return to the main menu.



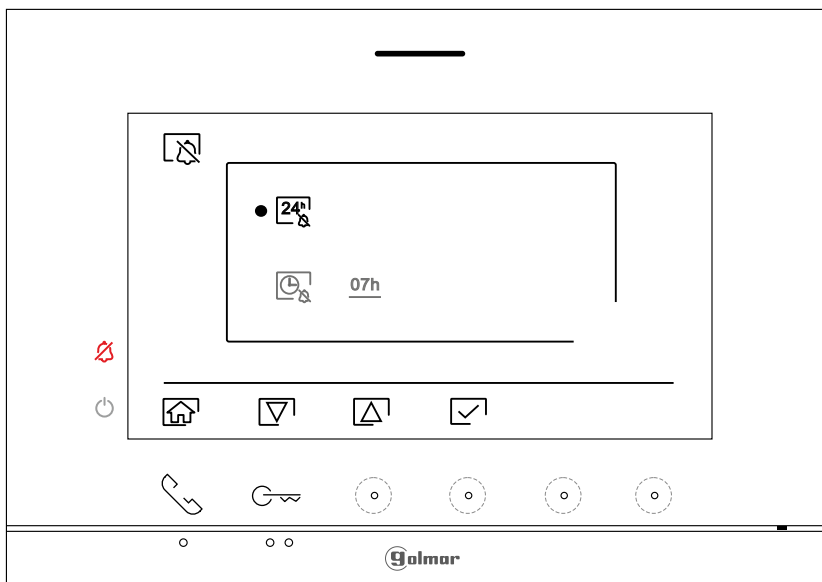





If you wish disable the 'Do not disturb' mode, go to the option with icon by pressing the button/ hidden button below corresponding icon / , deselect the option by pressing the button below icon and the notification icon will be switched off. Press the button below icon to return to the main menu. **Note:** From the main menu, you can also disable the 'Do not disturb' function by pressing the hidden button below icon .



Continued from previous page.
ART 7 LITE/G2+ MONITOR

Period of time for 'do not disturb' mode menú



To set a period of time for "Do not disturb" mode in which the monitor will not sound when receiving calls (see note "HZ" page 9), go to the option with icon  pressing the button/ hidden button below corresponding icon / and select the option by pressing the button below icon . Then you can set a period of time (from 1h to 24h) for 'Do not disturb' mode, by pressing corresponding hidden buttons /, and validate the changes made by pressing the button below icon , the notification icon  will illuminate and return to the main menu screen.

Time period setting screen

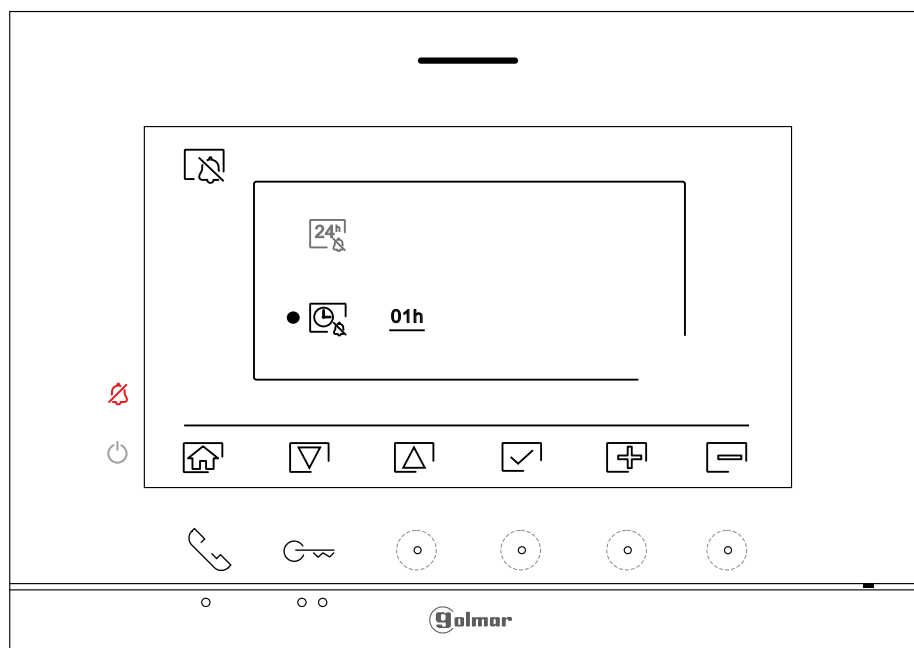

From the main menu, you can also disable the 'Do not disturb' function regardless of the timer status by pressing the hidden button below icon .

Main menu

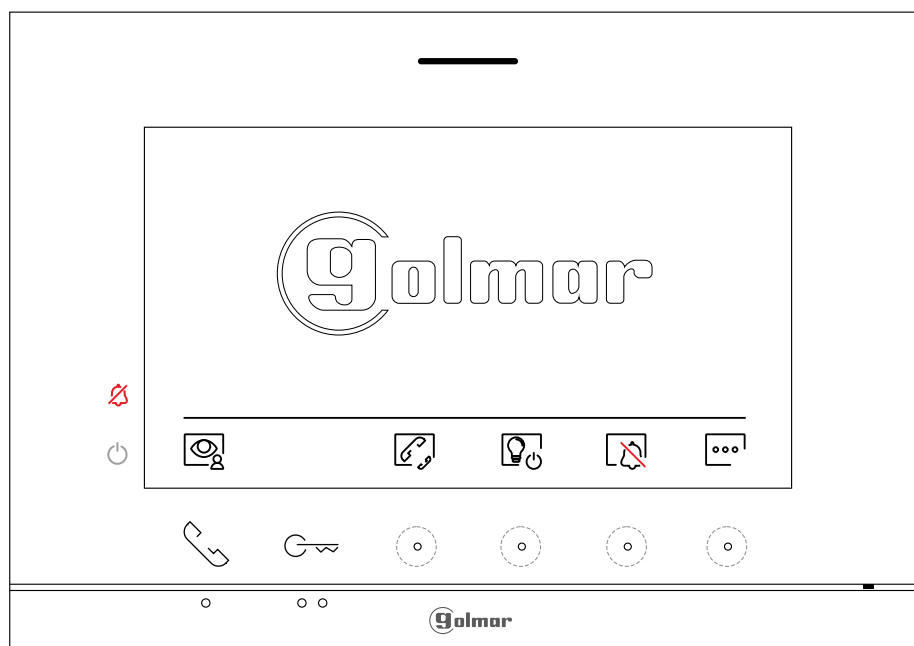

ART 7 LITE/G2+ MONITOR

Intercom menu

Access the intercom menu as described on p. 10. From this menu, you can contact another monitor(s) in your apartment (internal intercom)





Select option  to perform an internal intercom call.

If during an intercom process with another monitor a call is received from the door panel, the intercom process will be terminated, and the door panel call will be received on the corresponding monitor.





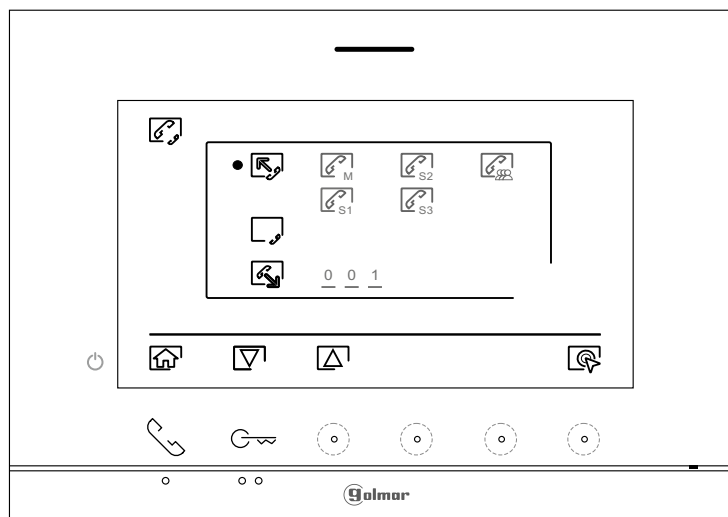

The selection  and : Not use.

Press the button below icon  to return to the main menu.



To make an internal intercom call (to another monitor(s) in the same apartment), go to the option with icon  by pressing the button/hidden button below corresponding icons / and press the hidden button below icon  to access the monitor selection menu (in the same apartment). Note: You will find information about the monitor itself with the address, Master, Slave 1 to Slave 3 of the monitor in the 'About' menu, (see p. 11).



Then press the button/hidden button below icons / to select the monitor to be called and press the hidden button below icon  to make the call. The monitor making the call will play a confirmation melody and indicate with a blink the monitor called. To cancel the call, press the hidden button below icon . Press the button below icon  to return to the intercom menu. The monitor receiving the call will play a confirmation melody showing on screen with a blink the monitor making the call. Press the hidden button below icon  to establish communication and press the hidden button below icon  to end communication.

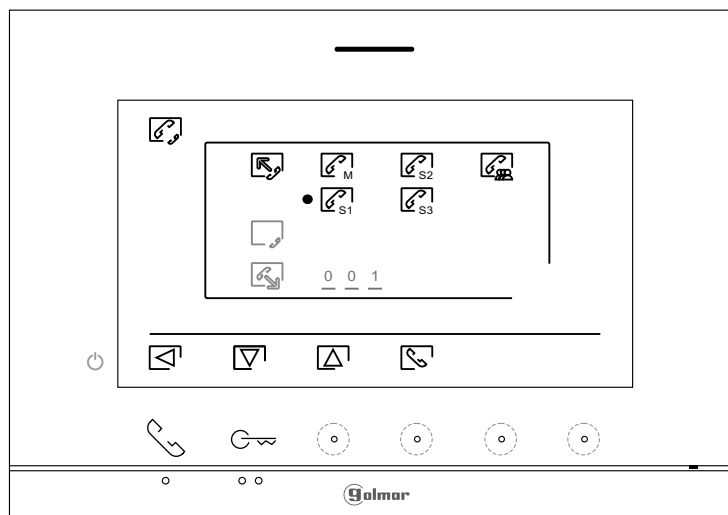

WIRING DIAGRAMS

Cross sections and distances

- Maximum 1 apartment.
- The maximum number of monitors in the apartment is 4.
- The maximum number of monitors in cascade is 4.
- Maximum two access door panels.

Type of cable	A	B	C
2 x 0,75mm ² (AWG18)	30m	30m	15m
CAT5 (*)	60m	60m	30m
RAP-GTWIN/HF	60m	60m	30m

- A. Distance between power supply and furthest door panel.
- B. Distance between power supply and furthest monitor (or distributor).
- C. Distance between a distributor and the furthest monitor connected to one of its outputs.

(*) Use two twisted pairs for each bus line.

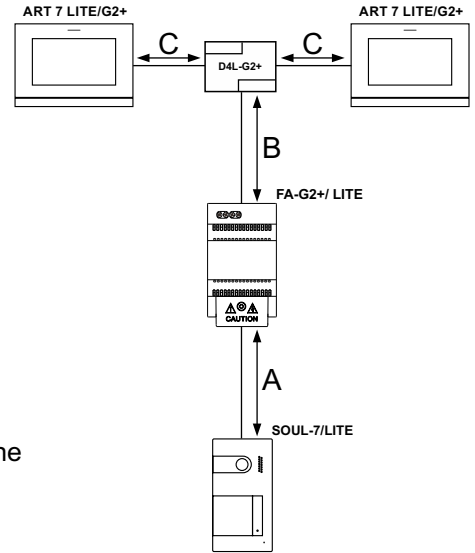

One apartment with one access panel and one monitor

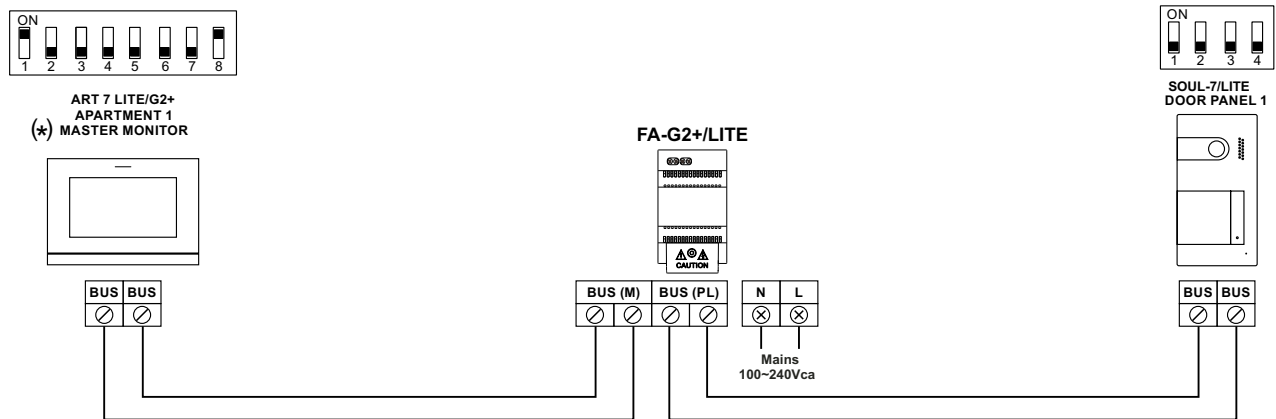

(*) Note: Monitor set to master (factory setting), see page 9.

One apartment with two access panels and one monitor

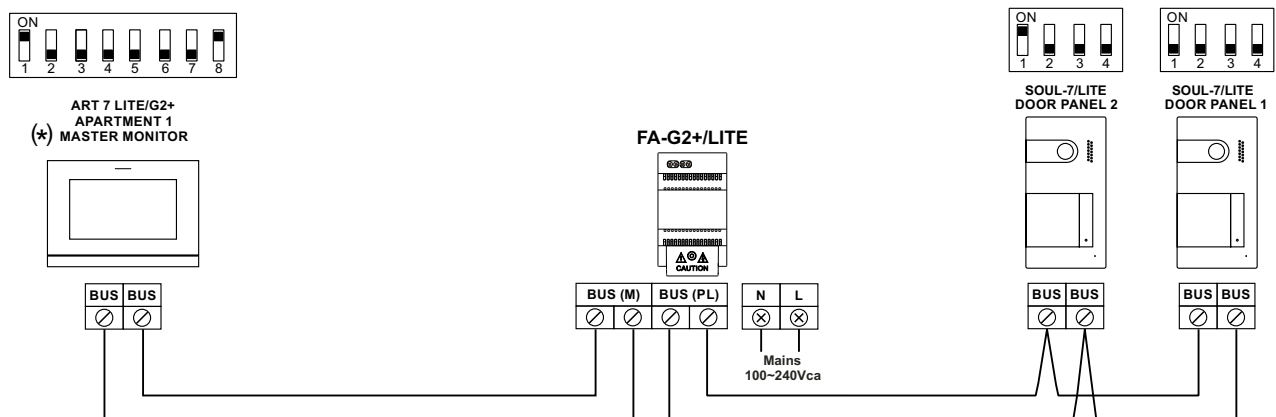

(*) Note: Monitor set to master (factory setting), see page 9.

WIRING DIAGRAMS

One apartment with up to two access panels and up to four monitors in cascade

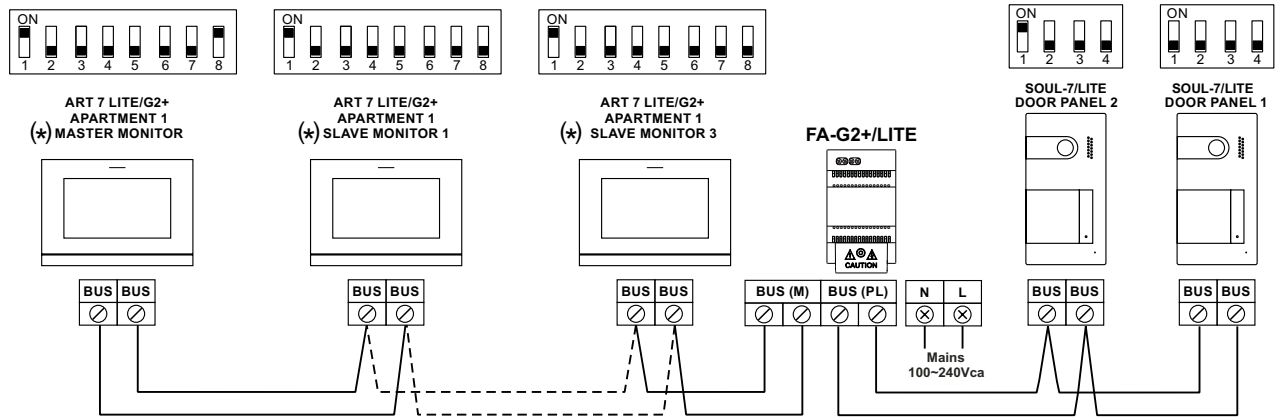

(* Note: To define whether the monitor is master (factory setting) or slave, see page 9.

One apartment with up to two access panels and up to four monitors in distribution

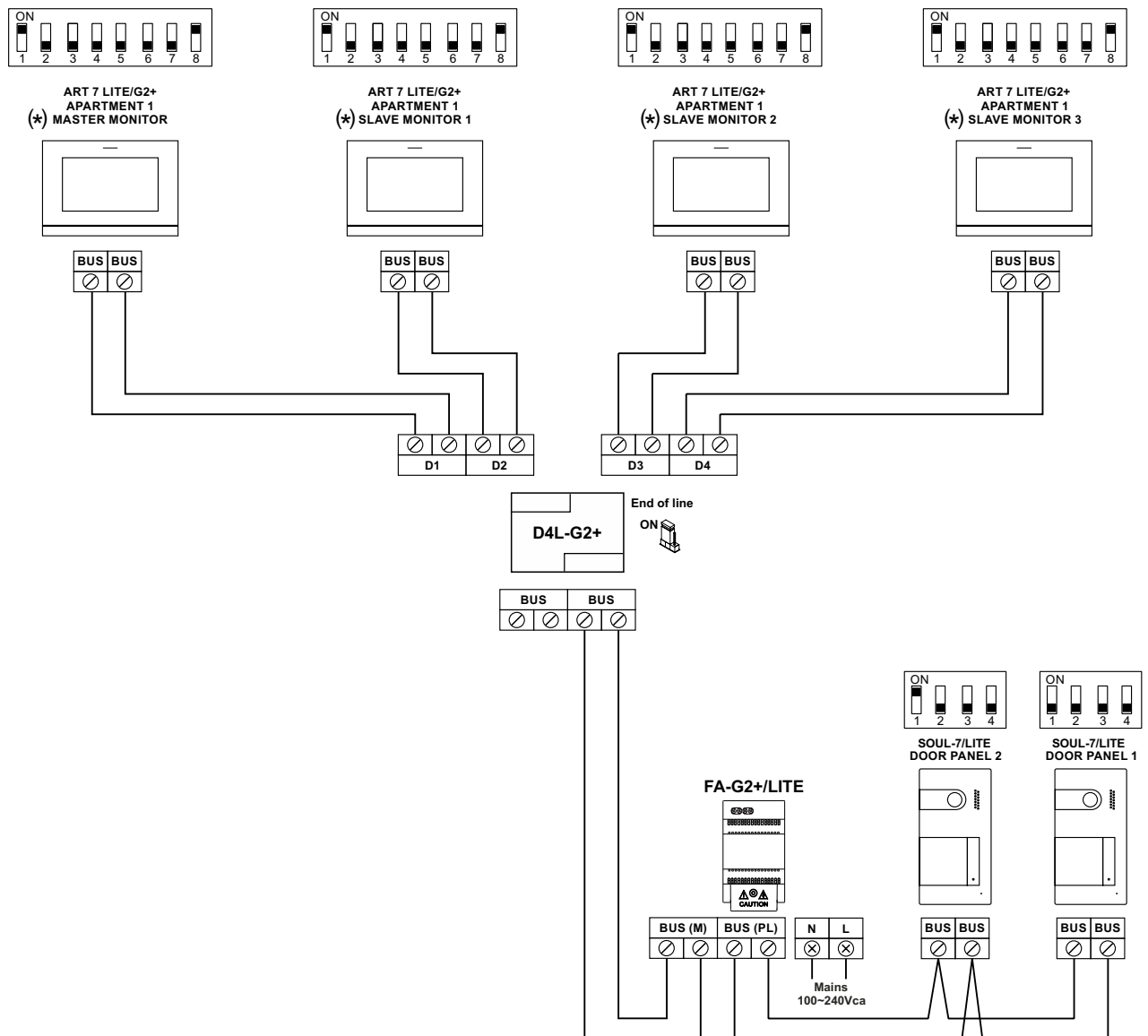

(* Note: To define whether the monitor is master (factory setting) or slave, see page 9.

WIRING DIAGRAMS

Connection of a lock release

The drawing shows the connection of a 12Vdc lock release, with a maximum consumption of 270mA. The use of Golmar CV-14/DC, CV-24/DC, CV-14P/UNI or CV-24P/UNI models is recommended. Activation is carried out through icon .

The activation time is 3 seconds, with the possibility of setting it to between 0.5 and 10 seconds (see pp. 25-26).

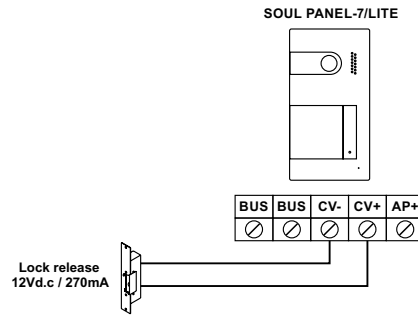

If the lock release to be used is alternating current, use a relay and transformer suitable for the consumption, as well as the varistor supplied. The example shows a Golmar SAR-12/24 relay and a TF-104 transformer (12Vac/1.5A).

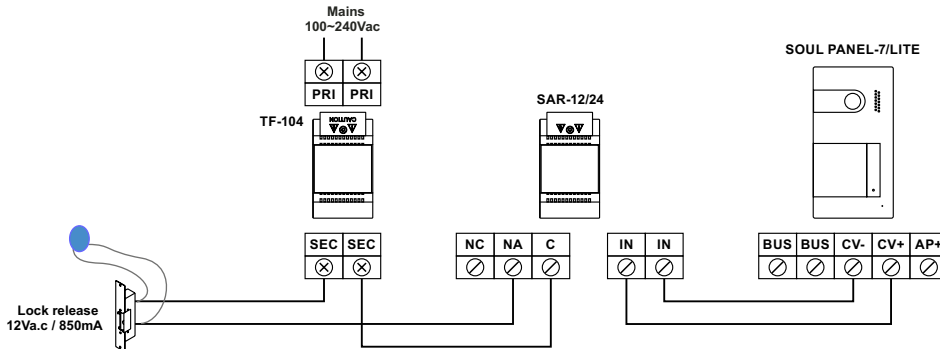

IMPORTANT: Installation with 2 access door panels and AP button on both door panels (see page 24), one of the door panels must connect the AC lock release (instead of DC lock release).

Connection of an auxiliary device at the relay output

The drawing, by way of example, shows the connection of a second AC lock release. The relay can switch 6A/24V loads. Activation is carried out through icon .

The activation time is 3 seconds, with the possibility of setting it to between 0.5 and 10 seconds (see pp. 25-26).

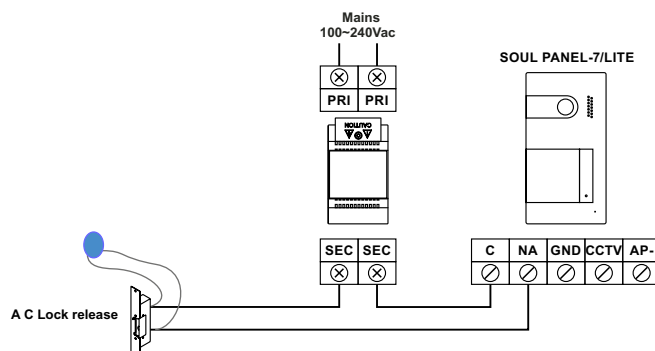

WIRING DIAGRAMS

Connection of an output button

The output button allows remote activation of the lock release connected between the CV- and CV+ terminals (by default) or the relay output (see pp. 25-26). The delay time in carrying out the activation is 2 seconds, with the possibility of setting it to between 0.5 and 10 seconds (see pp. 25-26).

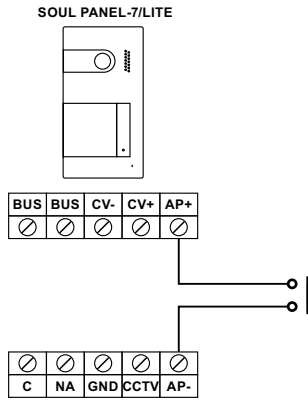

IMPORTANT: Installation with 2 access door panels and AP button on both door panels, one of the door panels must connect the AC lock release (instead of DC lock release) with a SAR-12/24 relay and a transformer TF-104, (see page 23).

Connection of an external camera

It is possible to connect a Golmar AHD4-3601x analogue CCTV camera to each of the door panels, which can be viewed (see pp. 25-26) from the monitor. The camera needs to have a local PSU-121 power supply.

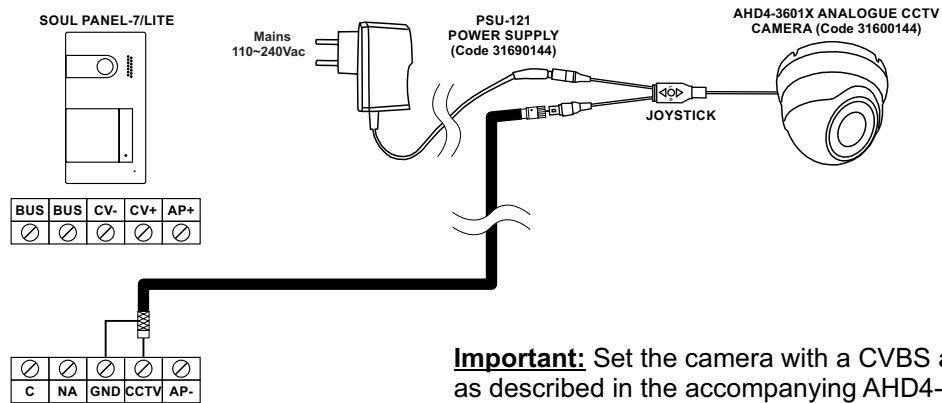

Important: Set the camera with a CVBS analogue signal, as described in the accompanying AHD4-3601x camera manual.

Connection for an apartment door button

Only connect the apartment door button to the master monitor of the apartment that will be receiving the call (see note "HZ" page 9). The signal received is then transmitted to the slave monitors in the same apartment.

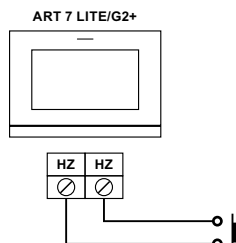

SPECIAL CODES

The enabling of some functions, as well as the modification of some factory parameters, can be carried out by entering special codes. To do so, the installer menu must be accessed from the monitor. Go to the 'About' screen in the Settings menu (p. 11) and press five times on the button located above the raised dot for the visually impaired ●● .

'About' screen

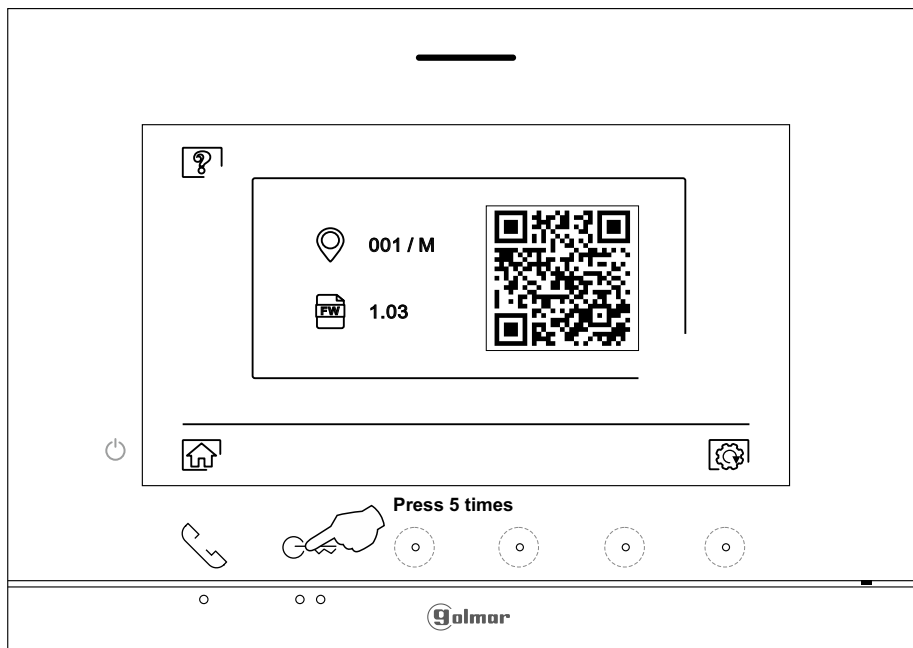

The 'special codes' screen will then be displayed. Press the button/ hidden button below icons ▽ / ▲ to select the field to be modified and press the hidden buttons below icons ⊕ / ⊖ to enter the desired code. Once the code has been entered, press the hidden button below icon ✓ to validate it. If the code entered is valid, icon ✓ will be displayed; if it is not, icon ✗ will be shown.

Use icon ? to return to the 'About' screen.

'Special codes' screen

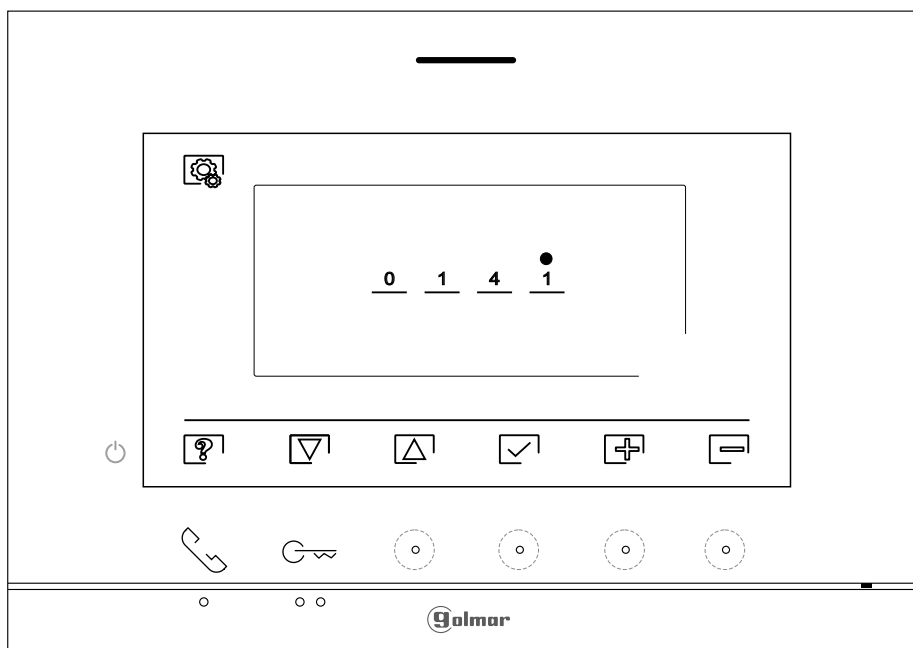

Continued from previous page.

SPECIAL CODES**Video sources available on a monitor (only setting on master monitor).**

	<u>Visible</u>	<u>No Visible</u>	<u>Factory setting</u>
Door panel 1	0111	0110	0111
Door panel 2	0121	0120	0120
Camera 1	0141	0140	0140
Camera 2	0181	0180	0180

To define whether the monitor is master or slave (Note: ART4 LITE/G2+ monitor with V.02 and next):

<u>Master</u>	<u>Slave 1</u>	<u>Slave 2</u>	<u>Slave 3</u>	<u>Factory setting</u>
0550	0551	0552	0553	0550 (master)

Automatic opening upon reception of a call on a monitor (only setting on master monitor).

<u>Activated</u>	<u>Deactivated</u>	<u>Factory setting</u>
0441	0440	0440

Activate/deactivate the ('power on indicator' notification icon) and (LEDs of the hidden buttons above raised dots ●/●● for the visually impaired) on a monitor.

<u>Activate</u>	<u>Deactivate</u>	<u>Factory setting</u>
0471	0470	0471 (activated)

Do not display the image on monitor when receiving a call from the door panel and the monitor is in "do not disturb" mode.

<u>Do not display</u>	<u>Display</u>	<u>Factory setting</u>
0481	0480	0480 (enable)

Enable/disable the icon  of the main menu in all monitors.

<u>Enable</u>	<u>Disable</u>	<u>Factory setting</u>
0541	0540	0541 (habilitado)

Activation times of the outputs (Door panel 1). (Only setting on master monitor).

	<u>Factory setting</u>
Lock release	From 0200 (0.5s) to 0219 (10s)0205 (3s)
Relay	From 0300 (0.5s) to 0319 (10s)0305 (3s)

Setting the remote activation button (Door panel 1). (Only setting on master monitor).

	<u>Factory setting</u>
Delay	From 0400 (0.5s) to 0419 (10s)0403 (2s)
Output	0430 (lock release) or 0431 (relay) 0430 (lock release)

Activation times of the outputs (Door panel 2). (Only setting on master monitor).

	<u>Factory setting</u>
Lock release	From 1200 (0.5s) to 1219 (10s)1205 (3s)
Relay	From 1300 (0.5s) to 1319 (10s)1305 (3s)

Setting the remote activation button (Door panel 2). (Only setting on master monitor).

	<u>Factory setting</u>
Delay	From 1400 (0.5s) to 1419 (10s)1403 (2s)
Output	1430 (lock release) or 1431 (relay) 1430 (lock release)

Night vision illuminaton leds (Door panel 1), during call or communication process. (Only setting on master monitor).

<u>Automatic</u>	<u>Always ON</u>	<u>Always OFF</u>	<u>Factory setting</u>
0450	0451	0452	0450 (automatic).

Night vision illuminaton leds (Door panel 2), during call or communication process. (Only setting on master monitor).

<u>Automatic</u>	<u>Always ON</u>	<u>Always OFF</u>	<u>Factory setting</u>
1450	1451	1452	1450 (automático)

Activate/ deactivate the ring tone (Door panel 1). (Only setting on master monitor):

<u>Activated</u>	<u>Deactivated</u>	<u>Factory setting</u>
1701	1700	1701

Activate/ deactivate the ring tone (Door panel 2). (Only setting on master monitor):

<u>Activated</u>	<u>Deactivated</u>	<u>Factory setting</u>
2701	2700	2701

CLEANING THE MONITOR

- Do not use solvents, detergents or cleaning products that contain acids, vinegar or abrasive components.
- Use a soft damp cloth (not wet) that sheds no fibres.
- Always wipe the monitor in the same direction, from top to bottom.
- After cleaning the monitor, remove any moisture with a soft dry cloth that sheds no fibres.

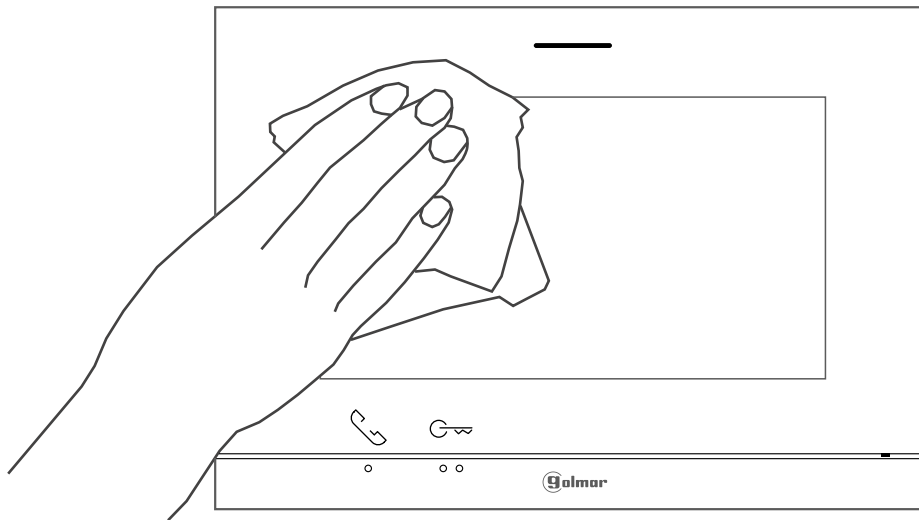

CLEANING THE DOOR PANEL

- Do not use solvents, detergents or cleaning products that contain acids, vinegar or abrasive components.
- Use a soft damp cloth (not wet) that sheds no fibres.
- Always wipe the door panel in the same direction, from top to bottom.
- After cleaning the door panel, remove any moisture with a soft dry cloth that sheds no fibres.

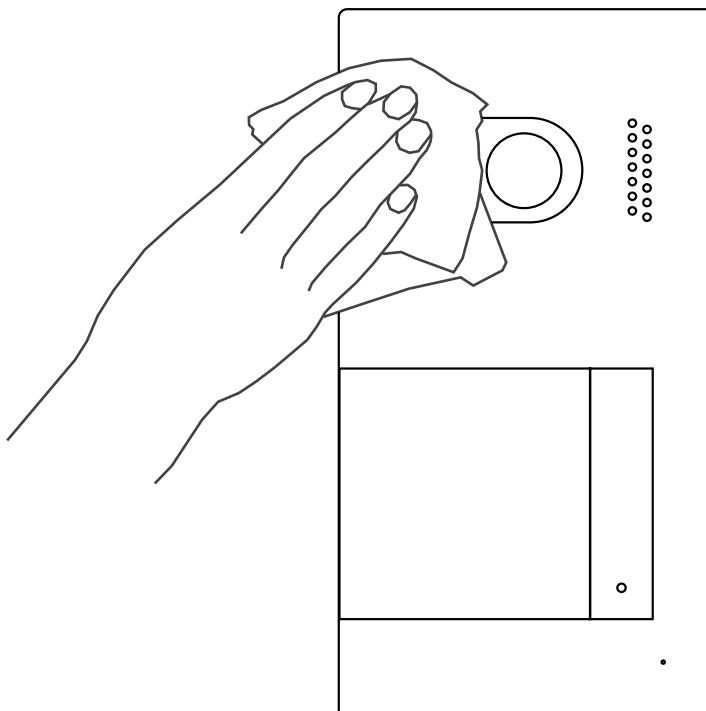

COMPLIANCE:

Este producto es conforme con las disposiciones de las Directivas Europeas aplicables respecto a la Seguridad Eléctrica **2014/35/CEE** y la Compatibilidad Electromagnética **2014/30/CEE**.

*This product meets the essentials requirements of applicable European Directives regarding Electrical Safety **2014/35/ECC** and Electromagnetic Compatibility **2014/30/ECC**.*



NOTA: El funcionamiento de este equipo está sujeto a las siguientes condiciones:

(1) Este dispositivo no puede provocar interferencias dañinas, y (2) debe aceptar cualquier interferencia recibida, incluyendo las que pueden provocar un funcionamiento no deseado.

NOTE: Operation is subject to the following conditions:

(1) This device may not cause harmful interference, and (2) this device must accept any received interference, including the ones that may cause undesired operation.



golmar@golmar.es

www.golmar.es

GOLMAR S.A.
C/ Silici, 13
08940- Cornellá de Llobregat
SPAIN



Golmar se reserva el derecho a cualquier modificación sin previo aviso.

Golmar se réserve le droit de toute modification sans préavis.

Golmar reserves the right to make any modifications without prior notice.